

In-Line Filter

QFD5



Features and Benefits

- Duplex filter design
- Approved for API 5L use
- Element changeout from the top minimizes oil spillage
- Available with optional core assembly to accommodate coreless elements
- Offered with standard Q, QPML deep-pleated and QCLQF coreless elements in 16" and 39" lengths with Viton® seals as the standard
- Offered in 2" and 3" SAE J518 4-bolt flange Code 61 and ANSI 300# flange porting
- Integral inlet and outlet test points are standard on all models
- Various Dirt Alarm® options
- Also available in 4, 6 or 8 housing modular designs (contact factory)

350 gpm
1325 L/min
500 psi
35 bar

GH

RLT

KF5

SRLT

K9

2K9

3K9

QF5

QF5i

3QF5

QFD2

Model No. of filter in photograph is QFD516QZ10F48DPG.

Flow Rating:	Up to 175 gpm (675 L/min) for 2"; 350 gpm (1325 L/min) for 3" for 150 SUS (32 cSt) fluids
Max. Operating Pressure:	500 psi (35 bar)
Min. Yield Pressure:	Contact Factory
Rated Fatigue Pressure:	Contact Factory
Temp. Range:	-15°F to 200°F (-26°C to 93°C)
Bypass Setting:	Cracking: 30 psi (2.1 bar) Full Flow: 33 psi (2.3 bar) for 2"; 38 psi (2.6 bar) for 3"
Porting Base & Cap:	Ductile Iron
Element Case & Transfer Valve:	Steel
Weight of QFD5-16Q:	410.0 lbs. (186.0 kg) for 2"; 455.0 (206.0 kg) for 3"
Weight of QFD5-39Q:	562.0 lbs. (255.0 kg) for 2"; 607.0 (275.0 kg) for 3"
Element Change Clearance:	16Q 12.00" (305 mm) 39Q 33.80" (859 mm)

Filter Housing Specifications

QFD5

QF15

QLF15

SSQLF15

Type Fluid	Appropriate Schroeder Media
Petroleum Based Fluids	All E media (cellulose), Z-Media® and ASP® media (synthetic)
High Water Content	All Z-Media® and ASP® media (synthetic)
Invert Emulsions	10 and 25 µ Z-Media® and 10 µ ASP® media (synthetic)
Water Glycols	3, 5, 10 and 25 µ Z-Media® and all ASP® media (synthetic)
Phosphate Esters	All Z-Media® (synthetic) with H (EPR) seal designation and all ASP® media (synthetic)

Fluid Compatibility

PORT SIZE	DIM A	DIM B	DIM C	DIM D	DIM E	
					16Q	39Q
2" Ports	4.00 (101.6)	8.19 (208.0)	10.75 (273.1)	4.80 (121.9)	36.50 (927)	58.31 (1481)
3" Ports	5.1 (130.2)	11.07 (281.1)	13.63 (346.1)	7.00 (177.8)	39.38 (1000)	61.19 (1559)

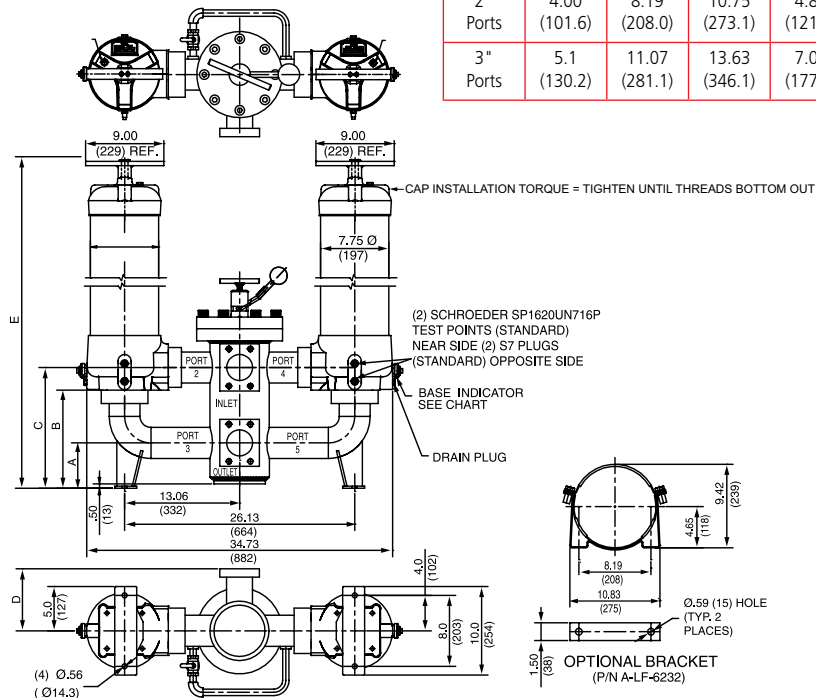

Metric dimensions in ().

Element Performance Information & Dirt Holding Capacity

Element	Filtration Ratio Per ISO 4572/NFPA T3.10.8.8 Using automated particle counter (APC) calibrated per ISO 4402			Filtration Ratio per ISO 16889 Using APC calibrated per ISO 11171		
	$\beta_x \geq 75$	$\beta_x \geq 100$	$\beta_x \geq 200$	$\beta_x(c) \geq 200$	$\beta_x(c) \geq 1000$	
16Q	Z1/CLQFZ1/PMLZ1	<1.0	<1.0	<1.0	<4.0	4.2
	Z3/CLQFZ3/PMLZ3	<1.0	<1.0	<2.0	<4.0	4.8
	Z5/CLQFZ5/PMLZ5	2.5	3.0	4.0	4.8	6.3
	Z10/CLQFZ10/PMLZ10	7.4	8.2	10.0	8.0	10.0
	Z25/CLQFZ25/PMLZ25	18.0	20.0	22.5	19.0	24.0
39Q	Z1/CLQFZ1/PMLZ1	<1.0	<1.0	<1.0	<4.0	4.2
	Z3/CLQFZ3/PMLZ3	<1.0	<1.0	<2.0	<4.0	4.8
	Z5/CLQFZ5/PMLZ5	2.5	3.0	4.0	4.8	6.3
	Z10/CLQFZ10/PMLZ10	7.4	8.2	10.0	8.0	10.0
	Z25/CLQFZ25/PMLZ25	18.0	20.0	22.5	19.0	24.0

Element	DHC (gm)	Element	DHC (gm)	Element	DHC (gm)	
16Q	Z1	276	CLQFZ1	307	PMLZ1	307
	Z3	283	CLQFZ3	315	PMLZ3	315
	Z5	351	CLQFZ5	364	PMLZ5	364
	Z10	280	CLQFZ10	306	PMLZ10	330
	Z25	254	CLQFZ25	278	PMLZ25	299
	39Q	Z1	974	CLQFZ1	1259	PMLZ1
Z3		1001	CLQFZ3	1293	PMLZ3	1525
Z5		954	CLQFZ5	1302	PMLZ5	1235
Z10		940	CLQFZ10	1214	PMLZ10	1432
Z25		853	CLQFZ25	1102	PMLZ25	1299

Element Collapse Rating: Q and QPML: 150 psid (10 bar), QCLQF: 100 psid (7 bar)

Flow Direction: Outside In

Element Nominal Dimensions: 39Q: 6.0" (150 mm) O.D. x 38.70" (985 mm) long
 39QCLQF: 6.0" (150 mm) O.D. x 40.01" (1016 mm) long
 39QPML: 6.0" (150 mm) O.D. x 37.80" (960 mm) long

$\Delta P_{\text{housing}}$

QFD5 $\Delta P_{\text{housing}}$ for fluids with sp gr (specific gravity) = 0.86:

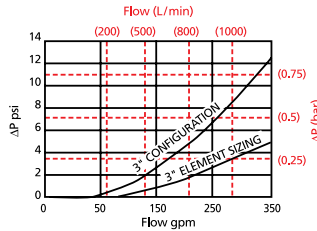
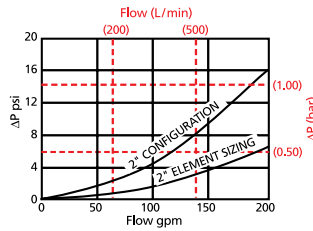

$\Delta P_{\text{element}}$

16QCLQFZ Element Pressure Drop versus Flow Rate at 32 cSt (150 SUS)

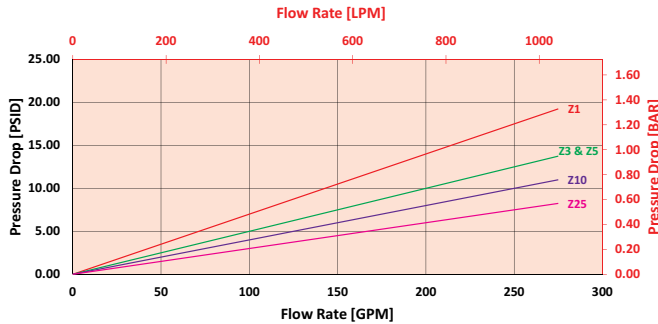

39QCLQFZ Element Pressure Drop versus Flow Rate at 32 cSt (150 SUS)

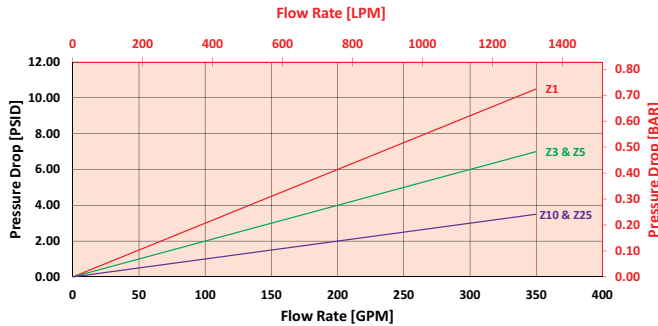

$$\Delta P_{\text{filter}} = \Delta P_{\text{housing}} + (\Delta P_{\text{element}} * V_f)$$

Exercise:

Determine ΔP_{filter} at 200 gpm (758 L/min) for QFD516QZ3F48D5C using 100 SUS (21.3 cSt) fluid.

Use the housing pressure curve to determine $\Delta P_{\text{housing}}$ at 200 gpm. In this case, $\Delta P_{\text{housing}}$ is 5 psi (.34 bar) on the graph for the QFD5 housing.

Use the element pressure curve to determine $\Delta P_{\text{element}}$ at 200 gpm. In this case, $\Delta P_{\text{element}}$ is 7 psi (.48 bar) according to the graph for the 16QCZ3 element.

Because the viscosity in this sample is 100 SUS (21.3 cSt), we determine the **Viscosity Factor (V_f)** by dividing the **Operating Fluid Viscosity** with the **Standard Viscosity** of 150 SUS (32 cSt). To best determine your Operating Fluid Viscosity, please reference the chart in Appendix D.

Finally, the overall filter pressure differential, ΔP_{filter} , is calculated by adding $\Delta P_{\text{housing}}$ with the true element pressure differential, $(\Delta P_{\text{element}} * V_f)$. The $\Delta P_{\text{element}}$ from the graph has to be multiplied by the viscosity factor to get the true pressure differential across the element.

Solution:

$$\Delta P_{\text{housing}} = 5 \text{ psi } [.34 \text{ bar}] \quad | \quad \Delta P_{\text{element}} = 7 \text{ psi } [.48 \text{ bar}]$$

$$V_f = 100 \text{ SUS } (21.3 \text{ cSt}) / 150 \text{ SUS } (32 \text{ cSt}) = .67$$

$$\Delta P_{\text{filter}} = 5 \text{ psi } + (7 \text{ psi } * .67) = 9.7 \text{ psi}$$

OR

$$\Delta P_{\text{filter}} = .34 \text{ bar } + (.48 \text{ bar } * .67) = .66 \text{ bar}$$

Pressure Drop Information Based on Flow Rate and Viscosity

GH

RLT

KF5

SRLT

K9

2K9

3K9

QF5

QF5i

3QF5

QFD2

QFD5

QF15

QLF15

SSQLF15

Note:

If your element is not graphed, use the following equation:
 $\Delta P_{\text{element}} = \text{Flow Rate} \times \Delta P_f$
 Plug this variable into the overall pressure drop equation.

Ele.	ΔP	Ele.	ΔP	Ele.	ΔP
16QAS3V	0.04	16QPMLZ1	0.08	39QZ1	0.03
16QAS5V	0.04	16QPMLZ3	0.05	39QZ3	0.01
16QAS10V	0.03	16QPMLZ5	0.05	39QZ5	0.01
16QPML-AS3V	0.05	16QPMLZ10	0.04	39QZ10	0.01
16QPML-ASSV	0.05	16QPMLZ25	0.02	39QZ25	0.01
16QPML-AS10V	0.04	39QAS3V	0.01	39QPMLZ1	0.03
16QZ1	0.09	39QAS5V	0.01	39QPMLZ3	0.02
16QZ3	0.04	39QAS10V	0.01	39QPMLZ5	0.02
16QZ5	0.04	39QPMLAS-3V	0.02	39QPMLZ10	0.01
16QZ10	0.03	39QPMLAS-5V	0.02	39QPMLZ25	0.01
16QZ25	0.01	39QPMLAS-10V	0.01		

Filter Model Number Selection

How to Build a Valid Model Number for a Schroeder QF5:

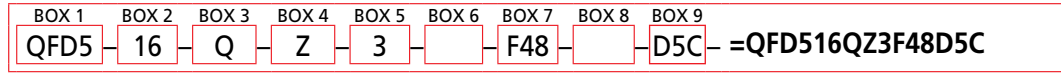
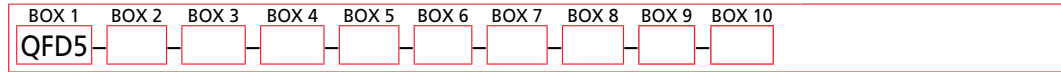

BOX 1	BOX 2	BOX 3	BOX 4	BOX 5
Filter Series	Element Length (in)	Element Style	Media Type	Micron Rating
QFD5	16 39	Q QCLQF QPML	Z = Excellement® Z-Media® (synthetic) AS = Anti-Stat Pleat media (synthetic) W = W media (water removal)	1 = 1 µm Z-Media® 3 = 3 µm Z-Media® 5 = 5 µm Z-Media® 10 = 10 µm Z-Media® 25 = 25 µm Z-Media®

BOX 6	BOX 7	BOX 8
Housing Seal Material	Porting	Bypass Setting
Omit = Buna N V = Viton®	F32 = 2" SAE 4-bolt flange Code 61 F32M = 2" SAE 4-bolt flange Code 61 FA32 = 2" ANSI 300# flange F48 = 3" SAE 4-bolt flange Code 61 F48M = 3" SAE 4-bolt flange Code 61 FA48 = 3" ANSI 300# flange	Omit = 30 psi cracking 50 = 50 psi cracking X = Blocked bypass

BOX 9	
Dirt Alarm® Options	
	Omit = None
Visual	DPG = Standard differential pressure gauge D5 = Visual pop-up D5C = D5 in cap
Visual with Thermal Lockout	D8 = Visual w/ thermal lockout D8C = D8 in cap
Electrical	MS5 = Electrical w/ 12 in. 18 gauge 4-conductor cable MS5LC = Low current MS5 MS10 = Electrical w/ DIN connector (male end only) MS10LC = Low current MS10 MS11 = Electrical w/ 12 ft. 4-conductor wire MS12 = Electrical w/ 5 pin Brad Harrison connector (male end only) MS12LC = Low current MS12 MS16 = Electrical w/ weather-packed sealed connector MS16LC = Low current MS16 MS17LC = Electrical w/ 4 pin Brad Harrison male connector
Electrical with Thermal Lockout	MS5T = MS5 (see above) w/ thermal lockout MS5LCT = Low current MS5T MS10T = MS10 (see above) w/ thermal lockout MS10LCT = Low current MS10T MS12T = MS12 (see above) w/ thermal lockout MS12LCT = Low current MS12T MS16T = MS16 (see above) w/ thermal lockout MS16LCT = Low current MS16T MS17LCT = Low current MS17T
Electrical Visual	MS13 = Supplied w/ threaded connector & light MS14 = Supplied w/ 5 pin Brad Harrison connector & light (male end)
Electrical Visual with Thermal Lockout	MS13DCT = MS13 (see above), direct current, w/ thermal lockout MS13DCLCT = Low current MS13DCT MS14DCT = MS14 (see above), direct current, w/ thermal lockout MS14DCLCT = Low current MS14DCT

NOTES:

Box 2. Replacement element part numbers are a combination of Boxes 2, 3, 4 and 5 plus the letter V.
Example: 39QZ10V

Box 3. QCLQF are CoreCentric® coreless elements – housing includes rigid metal core. QPML are deep-pleated elements with more media and higher dirt holding capacity.

Box 4. For option W, Box 3 must equal Q.

Box 6. All elements for this filter are supplied with Viton® seals. Seal designation in Box 6 applies to housing only. Viton® is a registered trademark of DuPont Dow Elastomers.